

TEXAS STAR SUPPLY

Office: 210-819-4751

www.texasstarsupply.com

11910 Radium Street San Antonio, TX 78216

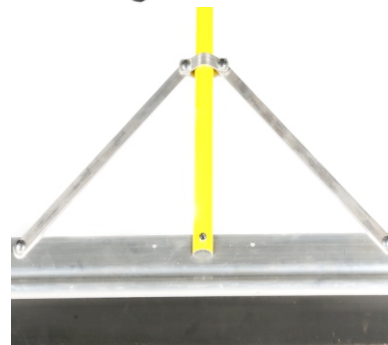
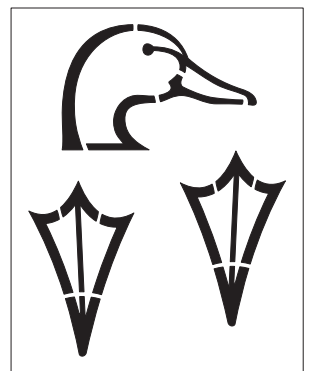
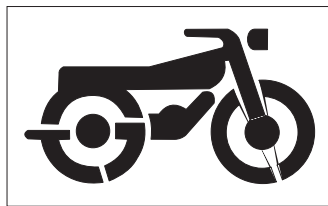
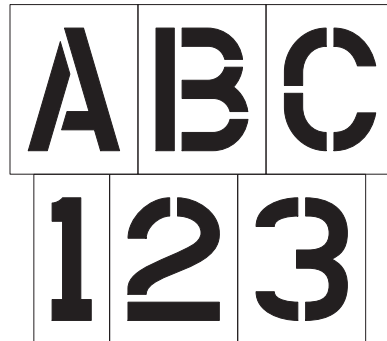
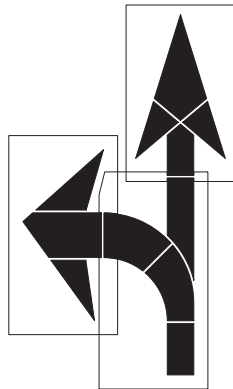

Our stencils are made from professional grade polyethylene.
 Duro is 1/16" thick polyethylene.
 Maxi is 1/8" thick polyethylene.
 Mylar stencils are 7 mil. thick.
 Magnetic stencils are 15 mil. thick.

STENCIL CONTENTS

PAGE #

ALPHABET KITS 2" - 10"	13
ALPHABET KITS 12" & 18"	14
ALPHABET KITS 24"	15
ALPHABET KITS 36", 42" 48"	16
ARROWS	5 & 7
BASKETBALL COURT	11
BIKE LANE	7
BIOHAZARD	9
BRASS STENCILS	17
BUCKLE UP FOR SAFETY	9
CARPOOL	9
FOOTBALL FIELD	10
FUEL EFFICIENT	9
HANDICAP SYMBOLS	5
HOPSCOTCH	11
INDIVIDUAL CHARACTER 72", 96"	16
LINE STENCILS	7
LOGOS	10
MAPS	11
MCDONALDS	9
MOTORCYCLE	7
NO DIVING	9
NUMBER KITS 2" - 10"	13
NUMBER KITS 12" & 18"	14
NUMBER KITS 24"	15
NUMBER KITS 36", 42", 48"	16
PEDESTRIAN	7
PLASTIC SHEETS	4
PLAYGROUND	11
RAILROAD	7
RECYCLING	9
SCHOOL LETTERS	10
SCHOOL LOGO	10
SHIPPING	7
SHUFFLEBOARD	11
STENCIL KITS	4
STENCILINKS	17
STOP BAR	7
TRACK LANE	10
TRAFFIC CONE	7
UNITED STATES MAP	11
WHEEL STOP OVERSPRAY	7
WORDING 2" - 10"	13
WORDING 12" & 18"	14
WORDING 24"	15
WORDING 36", 42"	16

PROTECT OUR ENVIRONMENT



DON'T DUMP

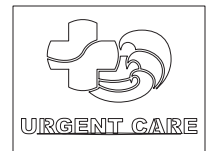
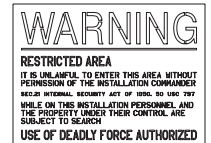
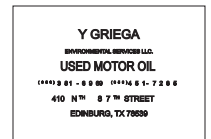
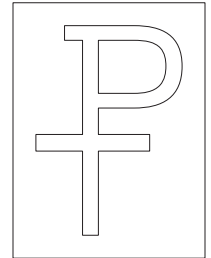
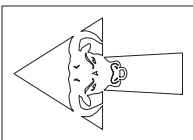
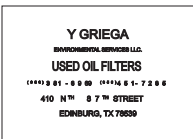

TOOL CONTENTS**PAGE #**

110' CHALK LINE	23
150' CHALK LINE	23
ADJUSTABLE SQUEEGEE	19
ADJUSTABLE SQUEEGEE REPLACEMENT BLADE	23
ALUMINUM HAND TAMP	21
ASPHALT DEPTH GAUGE	21
ASPHALT LUTE	19
ASPHALT RAKE	19
ASPHALT SCRAPER	21
BANDING MACHINE	21
BROOM HANDLES	21
BRUSHCOATER	21
CAR STOP SQUEEGEE	19
CAUTION TAPE 1000FT 1.5MIL	23
CLAMP STYLE SQUEEGEE	19
CLAMP STYLE SQUEEGEE REPLACEMENT BLADE	23
CRACK HOE	19
CRAYON HOLDER	23
HAND TAMP	21
LAYOUT CHALK	23
LAYOUT CRAYON	23
LUTE REPLACEMENT BLADE	23
OIL SPOT BROOM	21
PARKING LOT PROTRACTOR	23
POUR POT	21
POUR POT WHEELED	21
PREMARKED LAYOUT TAPE	23
REPLACEMENT BLADE	23
SCRAPER	21
SEALCOATING SPRAY TIPS	21
SEALCOATING SQUEEGEE	19
SPRAY TIPS	21
SPRING STEEL BLADE	23
STAINLESS STEEL BLADE	23
STAINLESS STEEL SCRAPER	21
STEEL HAND TAMP	21
STREET BROOM	21
U-SQUEEGEE	19
U-SQUEEGEE REPLACEMENT BLADE	23
V-SQUEEGEE	19
V-SQUEEGEE REPLACEMENT BLADE	23
WHEELED POUR POT	21
WIRE STREET BROOM	21
POLY STREET BROOM	21
FLAT WIRE BROOM	21
CHALK LINE	21
LUTE	19
LUMBER CRAYON	23

S-9648
4' X 8'
SHEET OF PLASTIC

S-12048
4' X 10'
SHEET OF PLASTIC





S-STSTENKIT

WITH 1 OF EACH
42" ARROW KIT
21 1/2" HANDICAP
12" FIRELANE
12" NO PARKING
12" NUMBER KIT
4" FIRELANE
4" NO PARKING
4" RESERVED
4" VISITORS



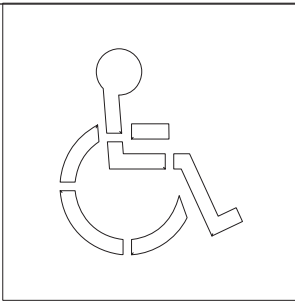
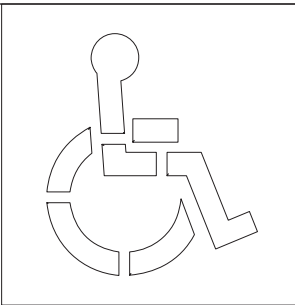
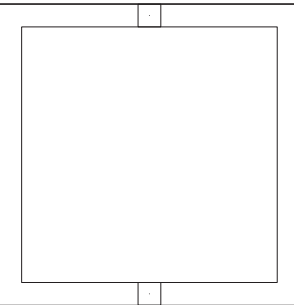

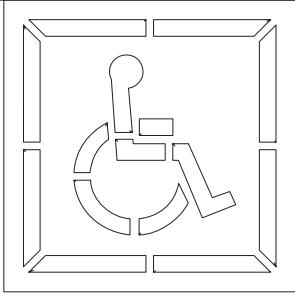
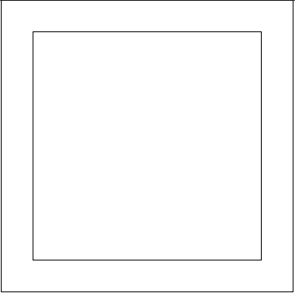

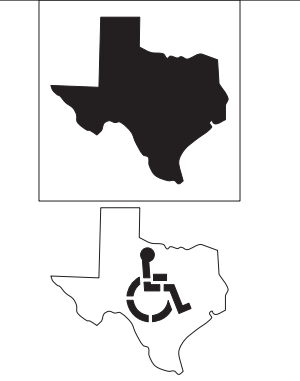
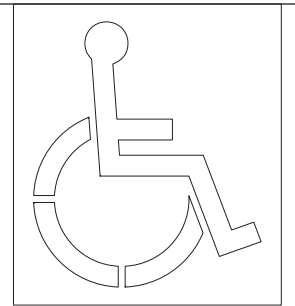
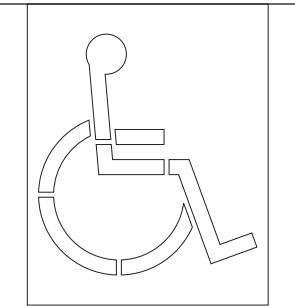
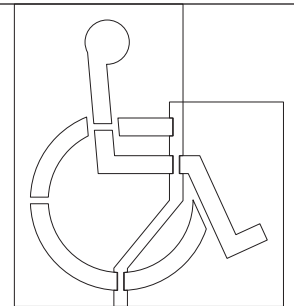
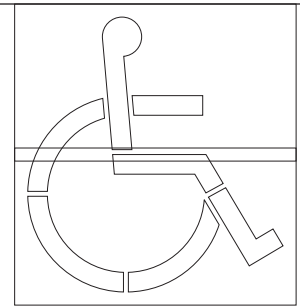
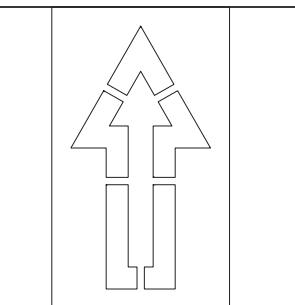
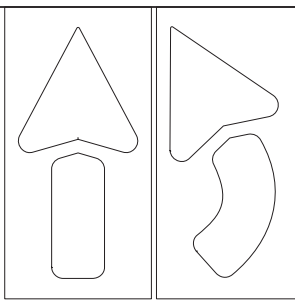
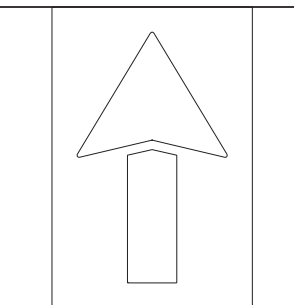
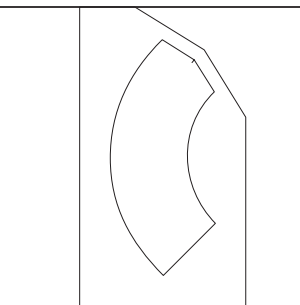
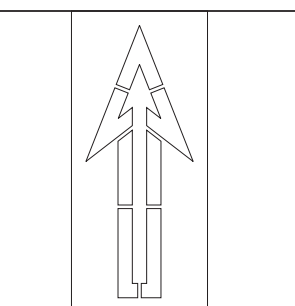
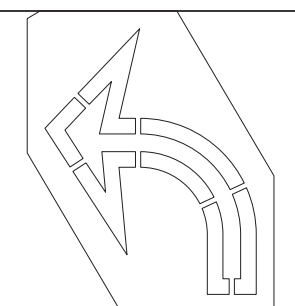
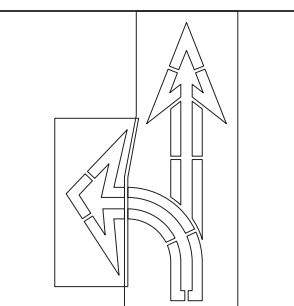
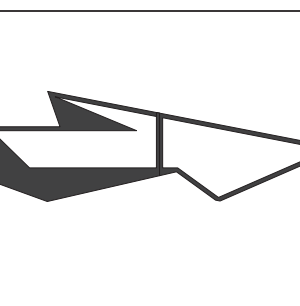



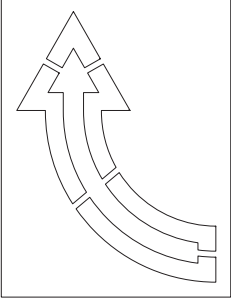
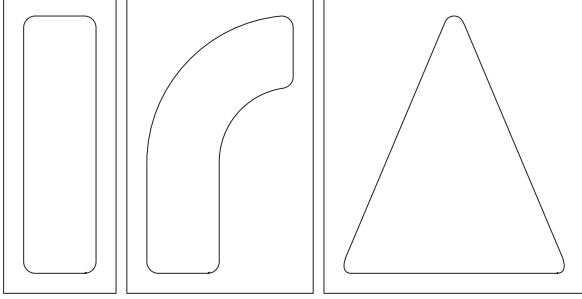
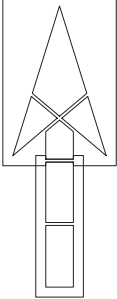
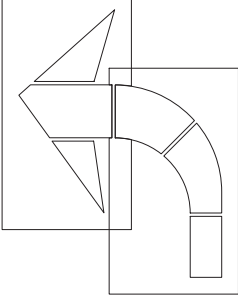
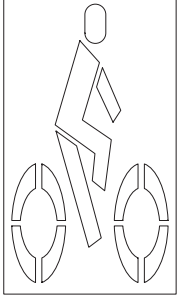
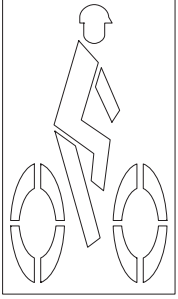
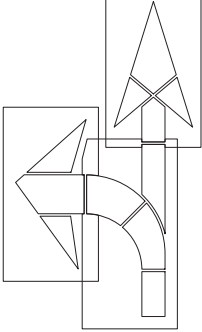
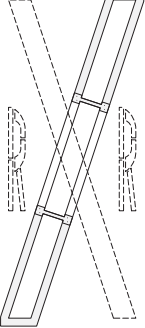

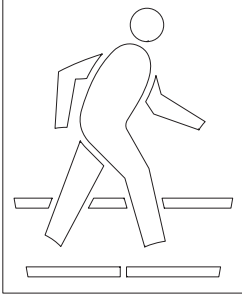
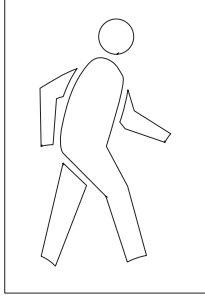
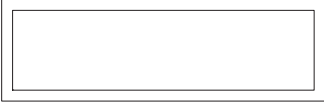
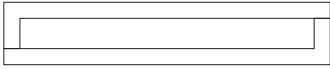
S-LGSTENKIT

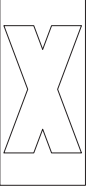
WITH 1 OF EACH
90" ARROW KIT
39" HANDICAP
24" FIRELANE
24" NO PARKING
12" NUMBER KIT
4" FIRELANE
4" NO PARKING
4" RESERVED
4" VISITORS

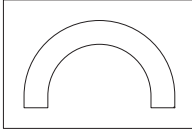
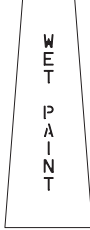
PART #	DURO	STENCIL DESCRIPTION	DURO	MAXI
	MAXI			
S-9648	D or M	4' X 8' PLASTIC SHEET	\$ 57.80	\$ 115.60
S-12048	D or M	4' X 10' PLASTIC SHEET	\$ 88.40	\$ 148.40
S-STSTENKIT	D or M	STANDARD STENCIL KIT - 9 PC KIT	\$ 321.00	\$ 622.40
S-LGSTENKIT	D or M	LARGE STENCIL KIT - 9 PC KIT	\$ 394.40	\$ 761.60
S-1513	D or M	15 1/2"h x 13 3/4"w HANDICAP SYMBOL, 1 1/4" STROKE	\$ 22.00	\$ 42.60
S-2119	D or M	21 1/2"h x 19"w HANDICAP SYMBOL, 1 1/2" STROKE	\$ 28.80	\$ 56.00
S-3934	D or M	39"h x 34"w HANDICAP SYMBOL, 4" STROKE	\$ 56.00	\$ 109.20
S-3934B	D or M	39" HANDICAP BACKGROUND	\$ 62.40	\$ 122.60
S-3939 STORK	D or M	39" X 39" STORK STENCIL	\$ 83.00	\$ 162.40
S-3042K	D or M	30" HANDICAP D.O.T. KIT (2 PC)	\$ 84.00	\$ 165.00
S-CAL28K	D or M	28" CALIFORNIA HANDICAP KIT (2 PC)	\$ 84.00	\$ 165.00
S-TEXAS40	D or M	40" TEXAS W/ 18" HANDICAP (2 PC)	\$ 140.80	\$ 270.00
S-4841	D or M	48"h x 41 1/4"w TEXAS HANDICAP, 4" STROKE	\$ 70.80	\$ 129.80
S-4843	D or M	48"h x 43 1/2"w CALIFORNIA HANDICAP, 3" STROKE	\$ 70.80	\$ 129.80
S-7263	D or M	72"h x 63"w HANDICAP SYMBOL, 2 PC, 5" STROKE	\$ 94.60	\$ 183.80
S-WAL84	D or M	84" WALMART HANDICAP (2 PC)	\$ 189.20	\$ 367.60
S-4524	D or M	45" WALMART STRAIGHT ARROW	\$ 112.00	\$ 216.00
S-4220K	D or M	42" STANDARD ARROW KIT (2PC)	\$ 56.00	\$ 109.20
S-4220S	D or M	42" STRAIGHT ARROW ONLY	\$ 28.00	\$ 54.60
S-4220C	D or M	42" CURVED ARROW ONLY	\$ 28.00	\$ 54.60
S-6036	D or M	60" STRAIGHT ARROW X 36" WIDE	\$ 70.80	\$ 129.80
S-6012	D or M	CURVED ARROW TAIL FOR S-6036	\$ 47.80	\$ 82.60
S-7630	D or M	76" STRAIGHT ARROW	\$ 130.00	\$ 250.00
S-6451	D or M	64" CURVED ARROW	\$ 141.00	\$ 270.00
S-10460	D or M	104" COMBO ARROW (2 PC)	\$ 161.80	\$ 325.00
S-LD18	D or M	18' LANE DROP ARROW	\$ 433.40	\$ 851.00

 <p>S-1513 or S-2119</p>	 <p>S-3934</p>	 <p>S-3934B</p>	 <p>S-3939STORK</p>
 <p>S-3042K or S-CAL28K</p>		 <p>S-TEXAS40</p>	
 <p>S-4841</p>	 <p>S-4843</p>	 <p>S-7263</p>	 <p>S-WAL84</p>
 <p>S-4524</p>	 <p>S-4220K, S, C</p>	 <p>S-6036</p>	 <p>S-6012</p>
 <p>S-7630</p>	 <p>S-6451</p>	 <p>S-10460</p>	 <p>S-LD18</p>

PART#	DURO	STENCIL DESCRIPTION	DURO	MAXI
	MAXI			
S-5742	D or M	57"h x 42"w WALMART CURVED ARROW	\$ 112.00	\$ 216.00
S-9036K	D or M	LARGE ARROW KIT (3 PC) 90" OAL	\$ 84.00	\$ 165.00
S-9036H	D or M	HEAD ONLY FOR S-9036, 42"h x 36"w	\$ 28.00	\$ 55.00
S-9036S	D or M	STRAIGHT TAIL ONLY FOR S-9036, 42"h x 12"w	\$ 28.00	\$ 55.00
S-9036C	D or M	CURVED TAIL ONLY FOR S-9036, 42"h x 24"w	\$ 28.00	\$ 55.00
S-12040	D or M	STRAIGHT HWY/INT ARROW KIT (2 PC), 120"h x 40"w	\$ 149.20	\$ 306.80
S-10076	D or M	CURVED HWY/INT ARROW KIT (2 PC), 100"h x 76"w	\$ 161.80	\$ 325.00
S-7844BIKE	D or M	6 ½ BICYCLE LANE SYMBOL, 44"w	\$ 67.40	\$ 133.40
S-7844BIKE-H	D or M	6 ½ BICYCLE LANE SYMBOL W/HELMET, 44"w	\$ 67.40	\$ 133.40
S-16090	D or M	160"h x 90"w HWY/INT COMBO ARROW KIT (3 PC)	\$ 261.40	\$ 525.20
S-240RRX	D or M	20' PIECE FOR RAILROAD X (PAINT TWICE)	\$ 163.80	\$ 316.80
S-7812RR	D or M	78"h x 12 ½"w RAILROAD "R", 3 ¼" STROKE	\$ 59.20	\$ 117.00
S-5444PED	D or M	54"h x 44"w PEDESTRIAN CROSSING SYMBOL	\$ 62.00	\$ 120.80
S-3016PED	D or M	30" PEDESTRIAN CROSSING SYMBOL	\$ 62.00	\$ 120.80
S-9024SB	D or M	STOP BAR STENCIL, width up to 24" x 76" long inside dim.	\$ 50.60	\$ 100.40
S-7808WS	D or M	WHEEL STOP OVERSPRAY KIT (2PC), 8' x 78" inside dim.	\$ 28.00	\$ 52.00
S-16804LINE	D or M	4" X 14' LINE STENCIL (2 PC)	\$ 68.40	\$ 136.80
S-72RRX	D or M	72" RAILROAD X	\$ 137.40	\$ 260.40
S-10739BIKE	D or M	107"h x 39"w BIKE SYMBOL with Chevrons	\$ 190.00	\$ 370.00
S-4460M	D or M	44"h x 60"w MOTORCYCLE with Rider	\$ 144.00	\$ 261.20
S-LOOP	D or M	LINE LOOP STENCIL, stock is 10"h x 12" ctr to ctr, 4" stroke	\$ 29.20	\$ 48.00
S-CONEKIT	D	TRAFFIC CONE WARNING KIT (5PC)	\$ 125.20	
S-WPCONE	D	1" (WET PAINT) TRAFFIC CONE STENCIL	\$ 28.00	
S-WSCONE	D	1" (WET SEALER) TRAFFIC CONE STEN.	\$ 28.00	
S-CAUCONE	D	1" (CAUTION) TRAFFIC CONE STENCIL	\$ 28.00	
S-KOCONE	D	1" (KEEP OUT) TRAFFIC CONE STENCIL	\$ 28.00	
S-WFCONE	D	1" (WET FLOOR) TRAFFIC CONE STENCIL	\$ 28.00	
S-INDSHIPKIT	D	SHIPPING STENCIL KIT (4 PC)	\$ 119.80	
S-08STACK	D	8" DO NOT STACK SYMBOL & WORDING	\$ 33.40	
S-08UP	D	8" THIS SIDE UP SYMBOL & WORDING	\$ 33.40	
S-08FRAG	D	8" FRAGILE SYMBOL & WORDING	\$ 33.40	
S-08CONT	D	8" CONTENTS SYMBOL & WORDING	\$ 33.40	
S-18CONE	D	TRAFFIC CONE I.D. STENCIL(18)"	\$ 68.80	
S-28CONE	D	TRAFFIC CONE I.D. STENCIL(28)"	\$ 80.40	
S-CUSTOM	D or M	CUSTOM STENCIL	CALL FOR PRICING	

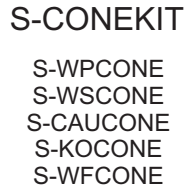

 <p>S-5742</p>	 <p>S-9036K, S, C, H</p>		 <p>S-12040</p>			
 <p>S-10076</p>	 <p>S-7844BIKE</p>	 <p>S-7844BIKE-H</p>	 <p>S-16090</p>			
 <p>S-21X8RRX</p>	 <p>S-7812RR</p>	 <p>S-5444PED</p>	 <p>S-3016PED</p>			
 <p>S-9024SB</p>	 <p>S-7808WS</p>	 <p>S-16804LINE</p>				
 <p>S-72RRX</p>	 <p>S-10739BIKE</p>	 <p>S-4460M</p>	 <p>S-LOOP</p>	 <p>WET PAINT</p>	 <p>WET SEALER</p>	 <p>CAUTION</p>
 <p>DO NOT STACK</p>	 <p>S-INDSHIPKIT</p>		 <p>FRAGILE</p>	 <p>S-18CONE S-28CONE</p>	 <p>S-CONEKIT</p> <ul style="list-style-type: none"> S-WPCONE S-WSCONE S-CAUCONE S-KOCONE S-WFCONE 	

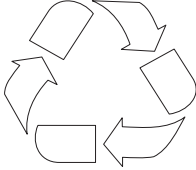
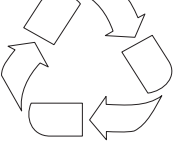
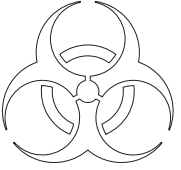
<u>PART#</u>	<u>DURO</u>	<u>STENCIL DESCRIPTION</u>	<u>DURO</u>	<u>MAXI</u>
	<u>MAXI</u>			
S-RECYCKIT	D or M	RECYCLING KIT (6 PIECE)	\$ 142.60	\$ 274.80
S-1602	D or M	16" RECYCLABLE LOGO W/ WORDING	\$ 48.20	\$ 94.60
S-2402BIO	D	BIOHAZARD SYMBOL & WORDING	\$ 54.20	
S-CHARGEPOINT	D or M	18" X 13' 1/2" CHARGEPOINT (2 PC)	\$ 272.00	\$ 538.80
S-2060FEV	D or M	4" FUEL EFFICIENT WORDING W/ GRAPHIC	\$ 108.20	\$ 208.00
S-1338CAR	D or M	4" CARPOOL PARKING WORDING W/ GRAP	\$ 85.60	\$ 164.80
S-39ELCAR	D or M	39" ELECTRIC CAR STENCIL	\$ 112.00	\$ 218.40
S-6648BUCK	D	BUCKLE UP FOR SAFETY	\$ 99.00	
S-3016FISH	D or M	DUMP NO WASTE-DRAINS TO STREAM	\$ 65.40	\$ 130.80
S-12SHOE	D or M	12" SHOEPRINT STENCIL	\$ 22.00	\$ 35.20
S-2418RS	D or M	24" X 18" RIDE SHARING STENCIL	\$ 75.00	\$ 146.00
S-2418CS	D or M	24" X 18" CAMPUS SHUTTLES STENCIL	\$ 75.00	\$ 146.00
S-2418PT	D or M	24" X 18" PUBLIC TRANSIT STENCIL	\$ 75.00	\$ 146.00
S-2418BK	D or M	24" X 18" BIKING STENCIL	\$ 75.00	\$ 146.00
S-2418PK	D or M	24" X 18" PARKING STENCIL	\$ 75.00	\$ 146.00
S-10NODIV	D or M	10" NO DIVING SYMBOL	\$ 22.00	\$ 35.20
S-2492STRIPES	D or M	24" X 92" STRIPES FOR SPEEDBUMPS	\$ 57.80	\$ 83.20
S-26NOSMOKE	D or M	26" NO SMOKING SYMBOL	\$ 45.60	\$ 88.00
S-8NOSHOP	D or M	8" NO SHOPPING CARTS SYMBOL	\$ 17.60	\$ 27.60
S-MCARCHES80	D or M	80" SKATEBOARDING ARCHES	\$ 177.00	\$ 324.00
S-MCARROW42	D or M	42" MCDONALDS ARROW IN CIRCLE	\$ 70.80	\$ 129.80
S-MCDRIVE34	D or M	34" MCDONALDS WORDING (DRIVE)	\$ 67.40	\$ 133.40
S-MCTHRU34	D or M	34" MCDONALDS WORDING (THRU)	\$ 67.40	\$ 133.40
S-MCTHANK34	D or M	34" MCDONALDS WORDING (THANK)	\$ 67.40	\$ 133.40
S-MCYOU34	D or M	34" MCDONALDS WORDING (YOU)	\$ 67.40	\$ 133.40
S-48FLOWER	D or M	48" FLOWER STENCIL	\$ 199.50	\$ 380.00
S-WORM	D	8" X 25' 9 1/2" WORM & 6" WORDING	\$ 328.80	

<p>RECYCLABLE</p> 	<p>S-RECYKIT</p> <p>WASTE ONLY</p> <p>PAPER ONLY</p>	<p>ALUMINUM CANS ONLY</p> <p>GLASS ONLY</p> <p>PLASTIC ONLY</p>	<p>RECYCLABLE</p> 	 <p>BIOHAZARD</p>
---	--	---	---	--

S-1602



S-2402BIO

<p>Charge Point</p>	 <p>FUEL EFFICIENT VEHICLE PARKING</p>	 <p>CARPOOL PARKING</p>
---------------------	---	--

S-CHARGEPOINT

S-2060FEV

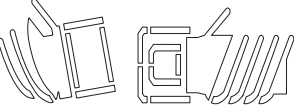
S-1338CAR







	<p>FOR SAFETY</p>  <p>BUCKLE-UP</p>	<p>DUMP NO WASTE</p>  <p>DRAINS TO STREAM</p>	
---	--	---	---

S-39ELCAR

S-6648BUCK

S-3016FISH

S-12SHOE

 <p>RIDE SHARING</p>	 <p>CAMPUS SHUTTLES</p>	 <p>PUBLIC TRANSIT</p>	 <p>BIKING</p>	 <p>PARKING</p>	
--	---	--	--	---	--

S-2418RS



S-2418CS

S-2418PT

S-2418BK

S-2418PK

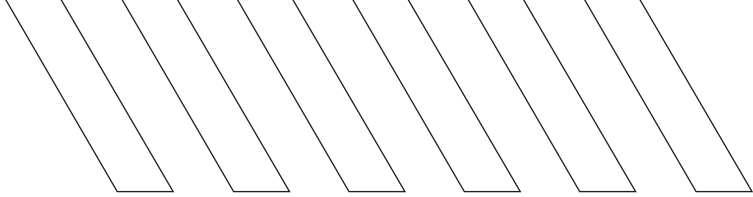
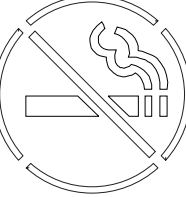
S-10NODIV

		
---	---	---

S-2492STRIPES

S-26NOSMOKE

S-8NOSHOP

		<p>THRU</p> <p>S-MCTHRU34</p> <p>DRIVE</p> <p>S-MCDRIVE34</p>	<p>YOU</p> <p>S-MCYOU34</p> <p>THANK</p> <p>S-MCTHANK34</p>	
---	---	---	---	---

S-MCARCHES80

S-MCARROW42

S-MCDRIVE34

S-MCTHANK34

S-48FLOWER

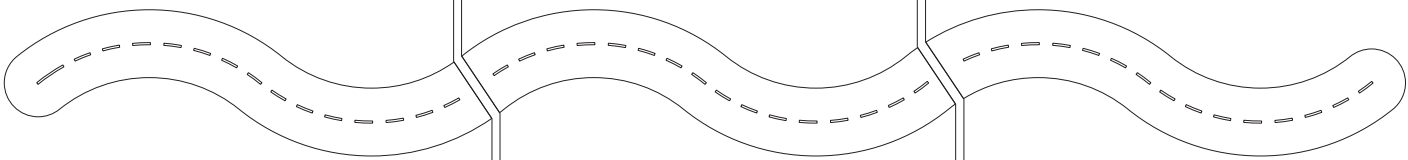

S-WORM

RACE YOUR FRIEND ALONG THE WORM!

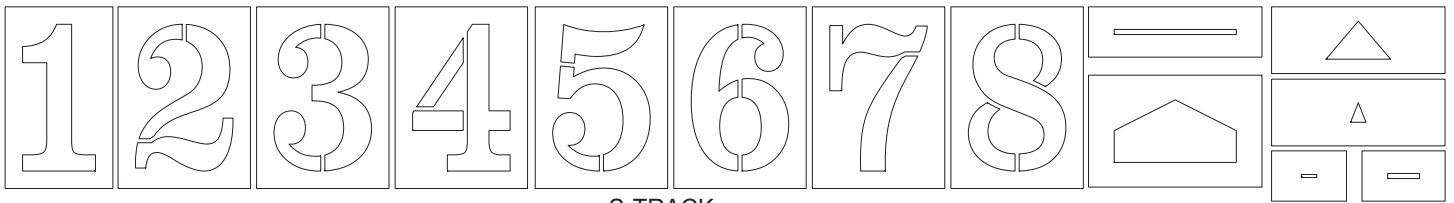

S-TRACK

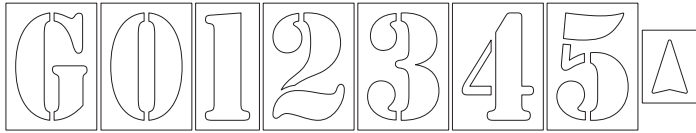

S-362408

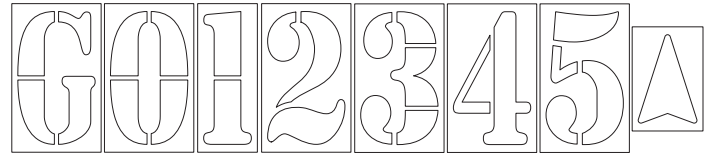

S-724208

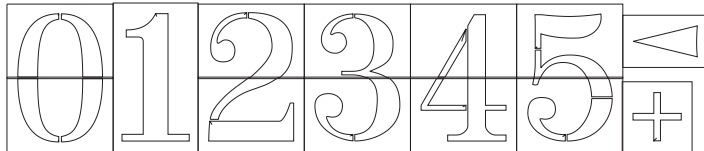

S-724808

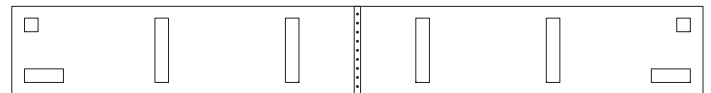

S-DSHMRK

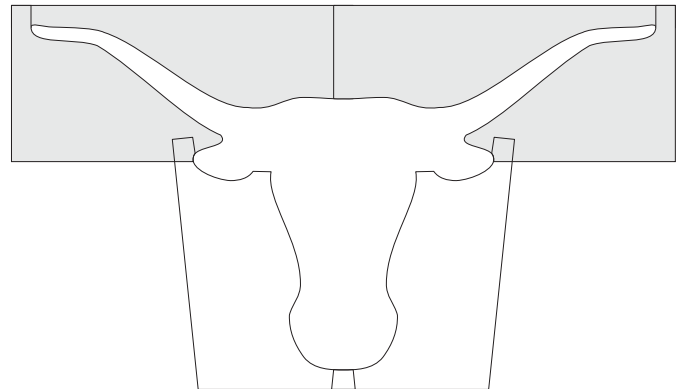
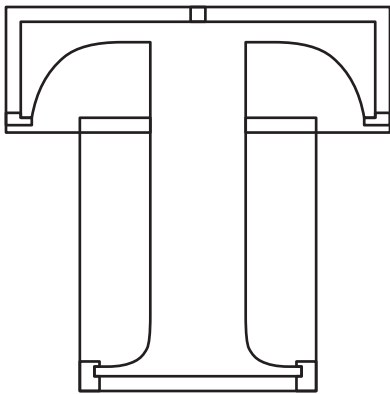

PART#	DURO	STENCIL DESCRIPTION	DURO	MAXI
	MAXI			
S-TRACK	D or M	TRACK LANE MARKING KIT	\$ 420.40	\$ 705.00
S-362408	D or M	3' FOOTBALL FIELD NUMBER KIT	\$ 333.80	\$ 580.60
S-724208	D or M	6' FOOTBALL FIELD NUMBER KIT	\$ 563.40	\$ 878.20
S-724808	D or M	6'PRO-STYLE FIELD KIT 012345+>	\$ 563.40	\$ 878.20
S-DSHMRK	D or M	FOOTBALL FIELD DASH MARK KIT	\$ 201.00	\$ 278.80
S-HELM1519	D	19 1/2' WIDE HELMET STENCIL	\$ 554.80	
S-HELM1514	D	PRO-STYLE HELMET STENCIL (2,20)	\$ 615.40	
S-HELM2025	D	25' WIDE HELMET STENCIL	\$ 1,169.80	
S-HELM2018	D	PRO-STYLE HELMET STENCIL(2,30)	\$ 1,291.00	
S-36LOGO	D	3' SQUARE SCHOOL LOGO STENCIL	\$ 289.20	
S-96LOGO	D	8' SQUARE SCHOOL LOGO STENCIL	\$ 433.40	
S-192LOGO	D	16' SQUARE SCHOOL LOGO STENCIL	\$ 722.20	
S-240LOGO	D	20' SQUARE SCHOOL LOGO STENCIL	\$ 1,372.00	
S-360LOGO	D	30' SQUARE SCHOOL LOGO STENCIL	\$ 2,165.80	
S-36ATHL	D or M	3' ROMAN SCHOOL LETTER	\$ 43.60	\$ 79.80
S-72ATHL	D or M	6' ROMAN SCHOOL LETTER	\$ 72.40	\$ 130.60
S-120ATHL	D	10' GOTHIC SCHOOL LETTERS	\$ 246.00	
S-144ATHL	D	12' GOTHIC SCHOOL LETTERS	\$ 289.20	
S-180ATHL	D	15' GOTHIC SCHOOL LETTER	\$ 361.20	
S-240ATHL	D	20' GOTHIC SCHOOL LETTER	\$ 505.60	
S-360ATHL	D	30' GOTHIC SCHOOL LETTER	\$ 722.20	



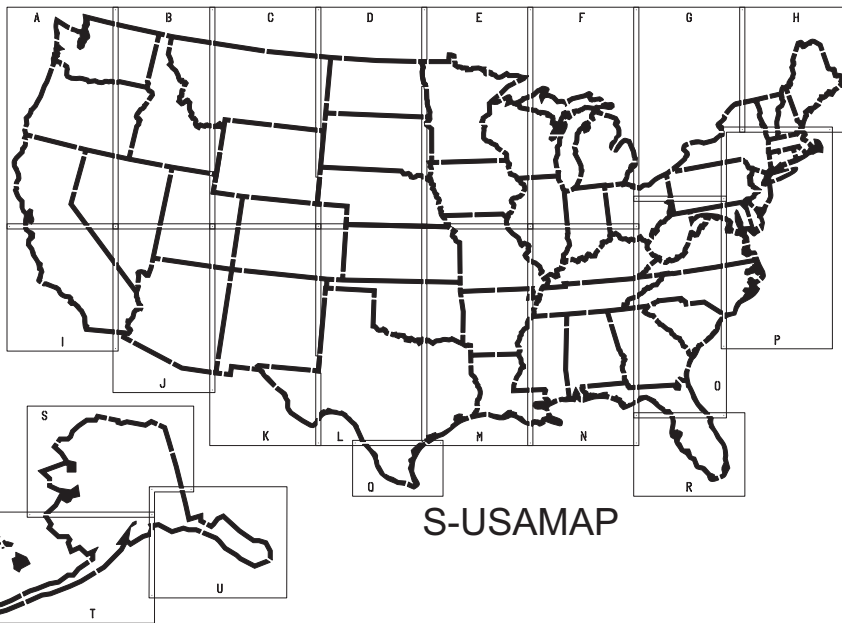

S-USAMAP



S-SNAIL

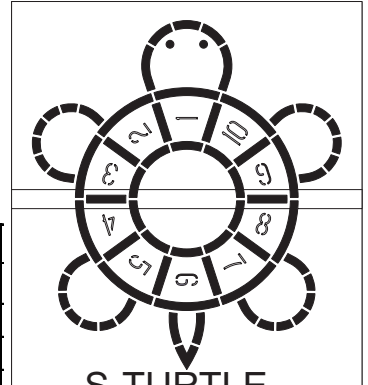

S-TURTLE

PART#	DURO	STENCIL DESCRIPTION	DURO	MAXI
	MAXI			
S-USAMAP	D	30' X 17' UNITED STATES MAP (20 PC)	\$ 2,165.80	
S-SNAIL	D	6' SNAIL STENCIL	\$ 433.40	
S-TURTLE	D	78" TURTLE HOP STENCIL	\$ 433.40	
S-ALPHAHOP	D	ALPHABET HOP STENCIL (10 PC)	\$ 1,660.00	
S-SHUFFLE	D or M	SHUFFLEBOARD KIT (10'L X 6'W)	\$ 406.20	\$ 653.00
S-90HOP	D or M	HOPSCOTCH KIT (7 1/2'L X 2'W)	\$ 90.80	\$ 177.80
S-108HOP	D or M	HOPSCOTCH KIT (9'L X 40"W)	\$ 122.40	\$ 232.80
S-CIRCLEKIT	D	BASKETBALL COURT CIRCLE KIT	\$ 118.60	
S-BBALLKIT	D	COMPLETE BASKETBALL KIT	\$ 391.60	
PAPER STENCILS			PRICE	
S-3536P		USA MAP STENCIL 35' X 36'	\$ 345.60	
S-2036P		WORLD MAP STENCIL 20' X 36'	\$ 403.40	

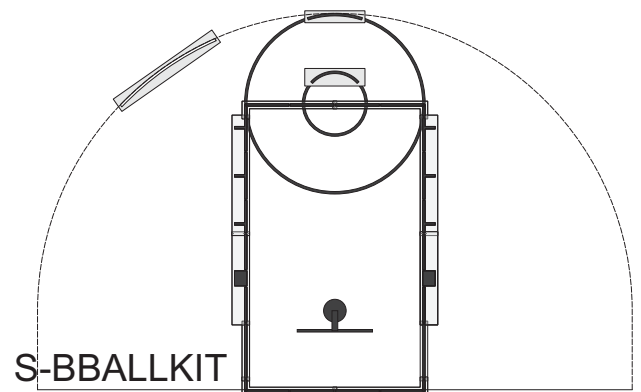
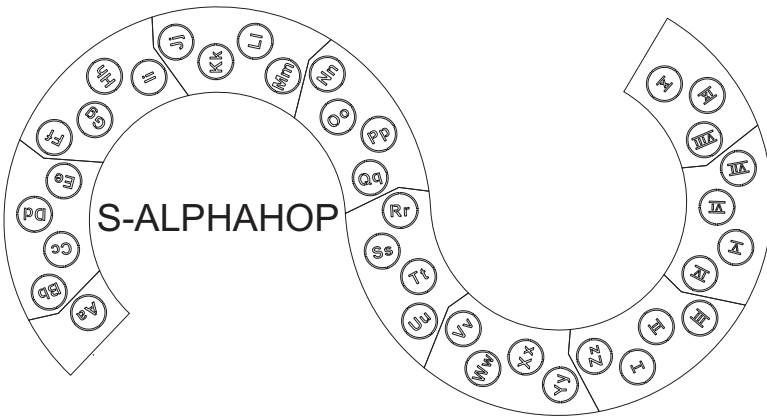

S-SHUFFLE

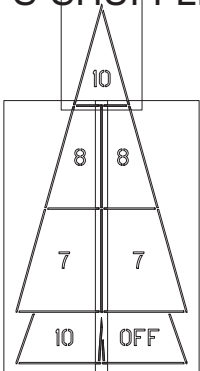

S-90HOP

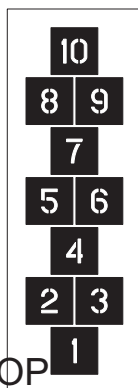

S-108HOP

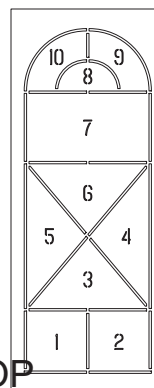

S-CIRCLEKIT

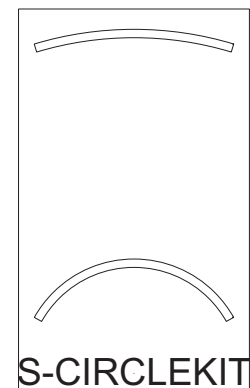

PART #	DURO MAXI	STENCIL DESCRIPTION	DURO	MAXI
S-020110	D or M	2" WORDING UP TO 10 LETTERS	\$ 21.40	\$ 41.20
S-020112	D or M	2" NUMBER KIT - 12 PC	\$ 24.20	\$ 41.20
S-020128	D or M	2" ALPHABET KIT - 28 PC	\$ 69.40	\$129.20
S-020163	D or M	2" MEGA NUMBER & ALPHA KIT 63 PC	\$ 109.00	\$198.60
S-020101	D or M	2" INDIVIDUAL CHARACTER	\$ 4.00	\$ 6.80
S-030210	D or M	3" WORDING UP TO 10 LETTERS	\$ 21.40	\$ 41.20
S-030212	D or M	3" NUMBER KIT - 12 PC	\$ 24.20	\$ 41.20
S-030228	D or M	3" ALPHABET KIT - 28 PC	\$ 69.40	\$129.20
S-030263	D or M	3" MEGA NUMBER & ALPHA KIT 63 PC	\$ 109.00	\$198.60
S-030201	D or M	3" INDIVIDUAL CHARACTER	\$ 4.00	\$ 6.80
S-040210	D or M	4" WORDING UP TO 10 LETTERS	\$ 21.40	\$ 41.20
S-040212	D or M	4" NUMBER KIT - 12 PC	\$ 24.20	\$ 41.20
S-040228	D or M	4" ALPHABET KIT - 28 PC	\$ 69.40	\$129.20
S-040263	D or M	4" MEGA NUMBER & ALPHA KIT 63 PC	\$ 109.00	\$198.60
S-040201	D or M	4" INDIVIDUAL CHARACTER	\$ 4.00	\$ 6.80
S-060410	D or M	6" WORDING UP TO 10 LETTERS	\$ 28.80	\$ 45.80
S-060412	D or M	6" NUMBER KIT - 12 PC	\$ 42.40	\$ 73.00
S-060428	D or M	6" ALPHABET KIT - 28 PC	\$ 119.60	\$203.00
S-060463	D or M	6" MEGA NUMBER & ALPHA KIT 63 PC	\$ 188.60	\$324.60
S-060401	D or M	6" INDIVIDUAL CHARACTER	\$ 6.40	\$ 10.40
S-080605	D or M	8" WORDING UP TO 5 LETTERS	\$ 26.80	\$ 45.80
S-080610	D or M	8" WORDING UP TO 10 LETTERS	\$ 40.60	\$ 74.80
S-080612	D or M	8" NUMBER KIT - 12 PC	\$ 60.00	\$105.00
S-080628	D or M	8" ALPHABET KIT - 28 PC	\$ 169.20	\$279.00
S-080663	D or M	8" MEGA NUMBER & ALPHA KIT 63 PC	\$ 263.40	\$447.00
S-080601	D or M	8" INDIVIDUAL CHARACTER	\$ 8.80	\$ 13.80
S-100705	D or M	10" WORDING UP TO 5 LETTERS	\$ 31.40	\$ 52.00
S-100710	D or M	10" WORDING UP TO 10 LETTERS	\$ 45.80	\$ 88.80
S-100712	D or M	10" NUMBER KIT - 12 PC	\$ 68.80	\$132.00
S-100728	D or M	10" ALPHABET KIT - 28 PC	\$ 180.00	\$326.40
S-100763	D or M	10" MEGA NUMBER & ALPHA KIT 63 PC	\$ 280.60	\$526.60
S-100701	D or M	10" INDIVIDUAL CHARACTER	\$ 9.40	\$ 16.20

NUMBER KITS- 12 PIECES

1 2 3 4 5 6 7 8 9 0 and 2 Blanks

ALPHABET KITS- 28 PIECES

A B C D E F G H I J K L M N O P Q R S T U V W X Y Z and 2 Blanks

MEGA NUMBER & ALPHABET KITS- 63 PIECES

A B C D E E E F G H I I J K L L M N N O O P Q R R S S S T T U
V W X Y Z 1 1 2 2 3 3 4 5 6 7 8 9 0 0 & # / () - , . and 4 Blanks

2" - 10"

A	B	C	D	E	F	G	H	I	J	K	L	M	N	O	P	Q	R
S	T	U	V	W	X	Y	Z	0	1	2	3	4	5	6	7	8	9

{	#	/	()	-	,	.
---	---	---	---	---	---	---	---

2" x 1.5" wide 3/8" stroke

3" x 2" wide 3/8" stroke

4" x 2.25" wide 1/2" stroke

6" x 4" wide 7/8" stroke

8" x 6" wide 1 1/2" stroke

10" x 7.5" wide 1 3/4" stroke

COMPACT

COMP

FIRE LANE

F/L

GUEST

GUEST

NO PARKING

N/P

ONLY

ONLY

RESERVED

RES

TOW AWAY ZONE

TAZ

VISITORS

VIS

RECYCLE

FIRE ZONE

CAUTION

OFFICE

12" x 9" wide 2" stroke

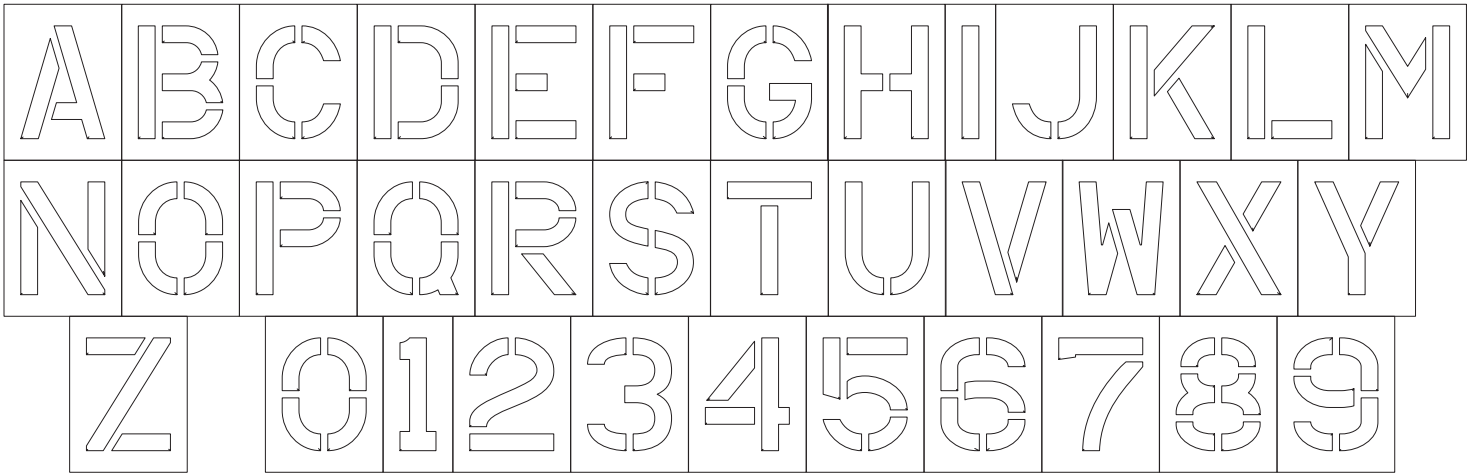

PART #	DURO	STENCIL DESCRIPTION	DURO	MAXI
	MAXI			
S-120905	D or M	12" WORDING UP TO 5 LETTERS	\$ 35.60	\$ 68.80
S-120910	D or M	12" WORDING UP TO 10 LETTERS	\$ 50.60	\$100.40
S-120912	D or M	12" NUMBER KIT - 12 PC	\$ 77.20	\$137.40
S-120928	D or M	12" ALPHABET KIT - 28 PC	\$ 219.00	\$353.60
S-120963	D or M	12" MEGA NUMBER & ALPHA KIT 63 PC	\$ 344.60	\$569.20
S-120901	D or M	12" INDIVIDUAL CHARACTER	\$ 11.00	\$ 17.60
S-180905	D or M	18" WORDING UP TO 5 LETTERS	\$ 42.60	\$ 80.80
S-180910	D or M	18" WORDING UP TO 10 LETTERS	\$ 61.40	\$120.60
S-180912	D or M	18" NUMBER KIT - 12 PC	\$ 113.20	\$200.60
S-180928	D or M	18" ALPHABET KIT - 28 PC	\$ 306.80	\$520.80
S-180901	D or M	18" INDIVIDUAL CHARACTER	\$ 13.80	\$ 23.00

18" x 9" wide 2" stroke

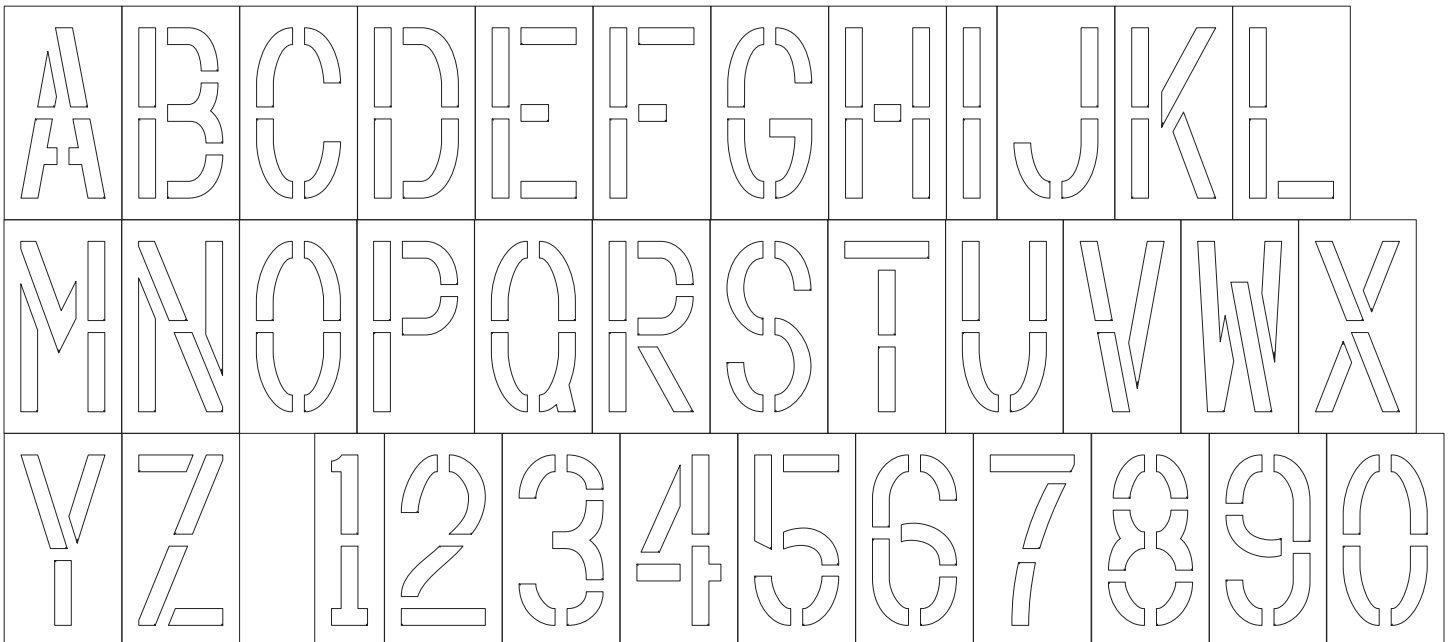

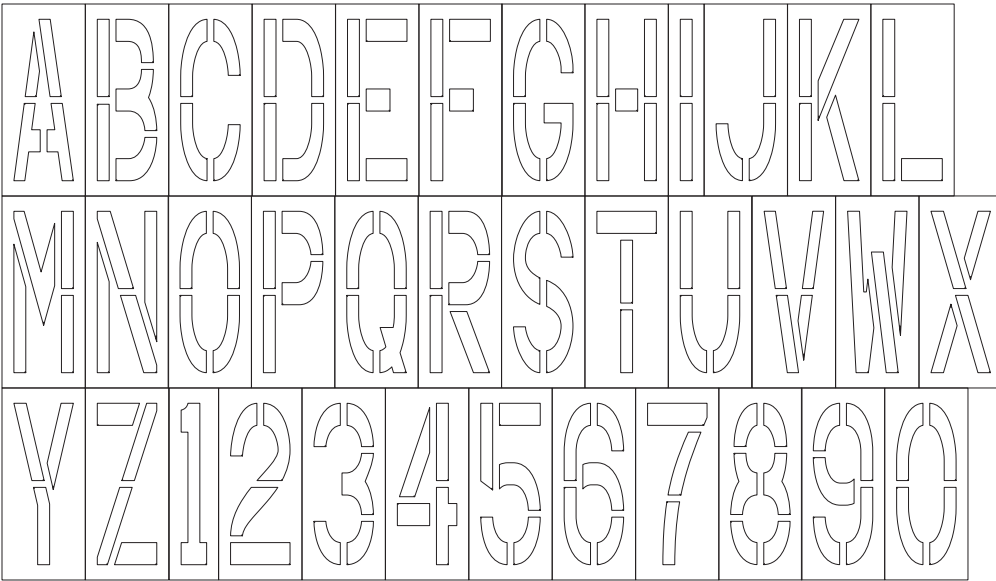

24" x 9" wide 2" stroke

PART #	DURO	STENCIL DESCRIPTION	DURO	MAXI
	MAXI			
S-240905	D or M	24" WORDING UP TO 5 LETTERS	\$ 49.40	\$ 94.60
S-240910	D or M	24" WORDING UP TO 10 LETTERS	\$ 72.60	\$ 144.80
S-240912	D or M	24" NUMBER KIT - 12 PC	\$ 136.20	\$ 254.80
S-240928	D or M	24" ALPHABET KIT - 28 PC	\$ 363.40	\$ 667.00
S-240901	D or M	24" INDIVIDUAL CHARACTER	\$ 16.20	\$ 29.40
S-241605	D or M	24" X 16" WORDING UP TO 5 LETTERS	\$ 73.60	\$ 142.00
S-241610	D or M	24" X 16" WORDING UP TO 10 LETTERS	\$ 108.60	\$ 217.20
S-241612	D or M	24" X 16" NUMBER KIT - 12 PC	\$ 204.20	\$ 382.40
S-241628	D or M	24" X 16" ALPHABET KIT - 28 PC	\$ 544.60	\$ 1,000.60
S-241601	D or M	24" X 16" INDIVIDUAL CHARACTER	\$ 24.20	\$ 44.00

24" x 16" wide 4" stroke

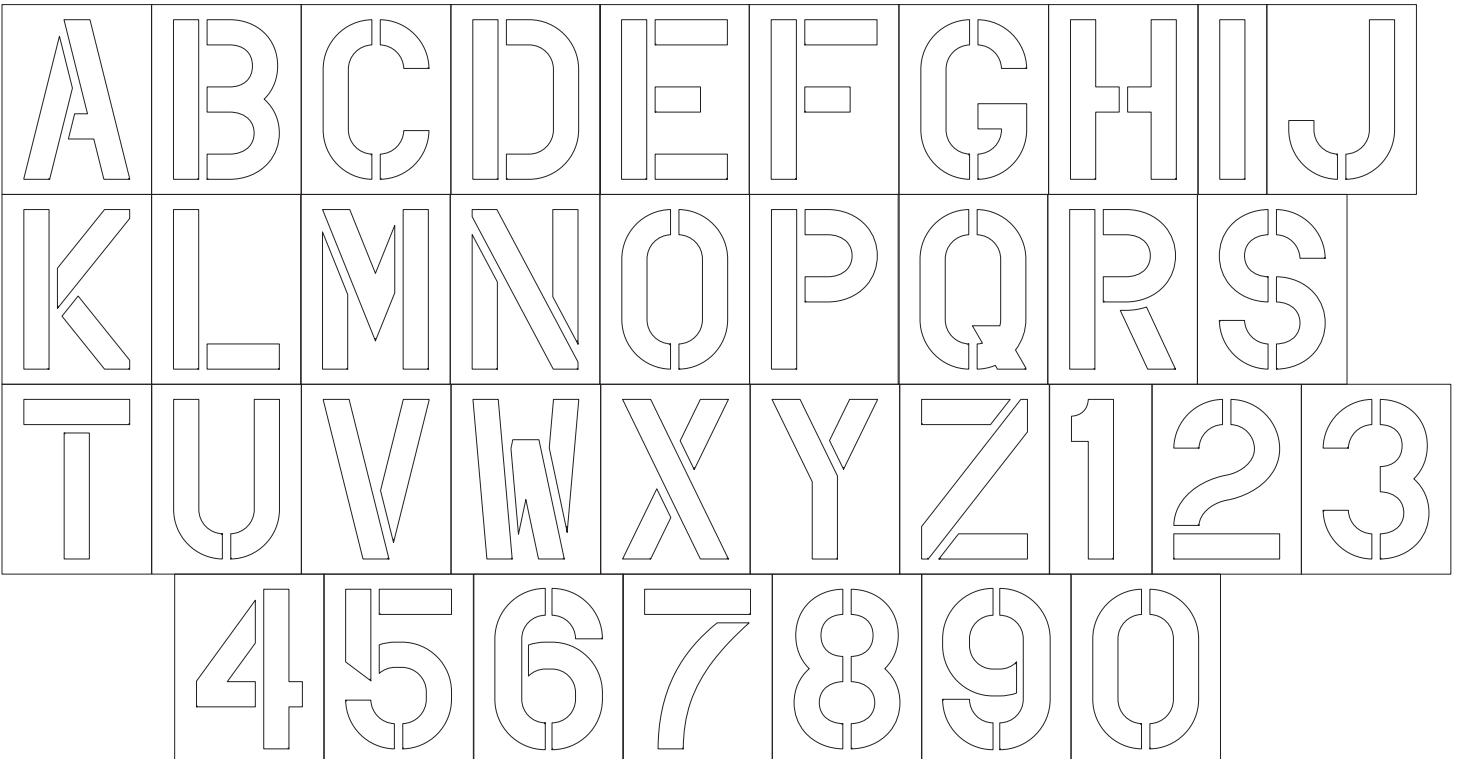

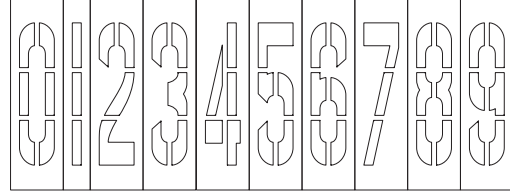

36" x 9" wide 2 1/2" stroke
 42" x 12" wide 2 1/2" stroke
 48" x 12" wide 3" stroke

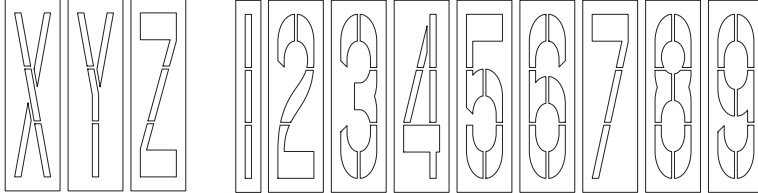

72" x 16" wide 3" stroke

PART #	DURO MAXI	STENCIL DESCRIPTION	DURO	MAXI
S-360905	D or M	36" WORDING UP TO 5 LETTERS	\$ 67.40	\$ 133.40
S-360910	D or M	36" WORDING UP TO 10 LETTERS	\$ 100.80	\$ 197.40
S-360912	D or M	36" NUMBER KIT - 12 PC	\$ 183.00	\$ 361.20
S-360928	D or M	36" ALPHABET KIT - 28 PC	\$ 486.00	\$ 953.20
S-360901	D or M	36" INDIVIDUAL CHARACTER	\$ 22.80	\$ 44.00
S-421205	D or M	42" WORDING UP TO 5 LETTERS	\$ 79.40	\$ 154.40
S-421210	D or M	42" WORDING UP TO 10 LETTERS (2 PC)	\$ 135.00	\$ 256.20
S-421212	D or M	42" NUMBER KIT - 12 PC	\$ 223.20	\$ 432.20
S-421228	D or M	42" ALPHABET KIT - 28 PC	\$ 579.60	\$ 1,123.00
S-421201	D or M	42" INDIVIDUAL CHARACTER	\$ 26.80	\$ 52.00
S-481212	D or M	48" NUMBER KIT - 12 PC	\$ 308.60	\$ 586.80
S-481228	D or M	48" ALPHABET KIT - 28 PC	\$ 804.40	\$ 1,517.80
S-481201	D or M	48" INDIVIDUAL CHARACTER	\$ 37.60	\$ 70.80
S-721601	D or M	72" INDIVIDUAL CHARACTER	\$ 45.80	\$ 86.80
S-961601	D or M	96" INDIVIDUAL CHARACTER	\$ 54.60	\$ 105.60

96" x 16" wide 4" stroke

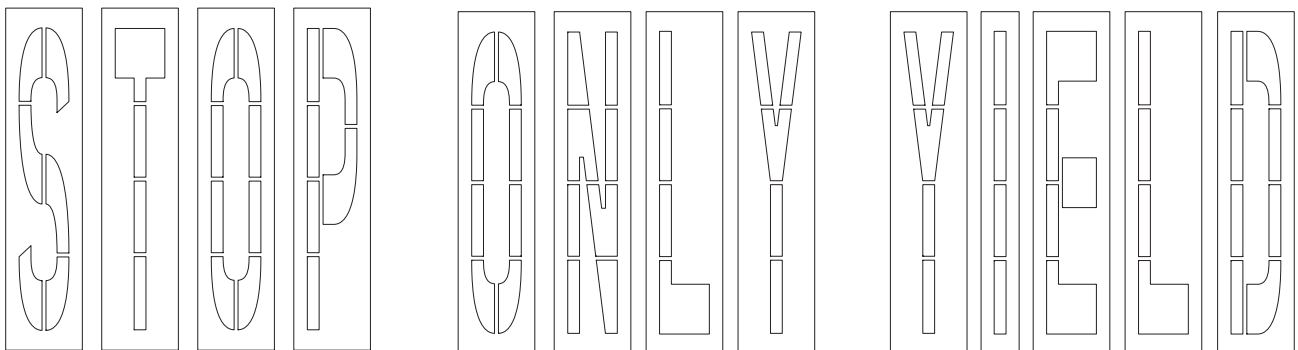



BRASS



STENCILINK



PART#	15 or 45 or 92	BRASS STENCILS	15 PC	45 PC	92 PC
BRASS-1	15 or 45 or 92	1" BRASS STENCIL KITS 15, 45, & 92 PCS	\$ 15.20	\$ 44.00	\$ 99.00
BRASS-2	15 or 45 or 92	2" BRASS STENCIL KITS 15, 45, & 92 PCS	\$ 23.80	\$ 67.20	\$ 148.20
BRASS-3	15 or 45 or 92	3" BRASS STENCIL KITS 15, 45, & 92 PCS	\$ 37.80	\$ 106.60	\$ 237.20
BRASS-4	15 or 45 or 92	4" BRASS STENCIL KITS 15, 45, & 92 PCS	\$ 55.80	\$ 159.30	\$ 350.00
BRASS-5	15 or 45 or 92	5" BRASS STENCIL KITS 15, 45, & 92 PCS	\$ 66.40	\$ 200.80	\$ 419.20
BRASS-6	15 or 45 or 92	6" BRASS STENCIL KITS 15, 45, & 92 PCS	\$ 84.40	\$ 252.20	\$ 518.50
STENCILINKS			DURO	MAXI	
STENCILINK-12	D or M	12" STENCILINK	\$ 2.00	\$ 2.20	
STENCILINK-24	D or M	24" STENCILINK	\$ 3.80	\$ 4.20	
STENCILINK-36	D or M	36" STENCILINK	\$ 5.60	\$ 6.20	
STENCILINK-42	D or M	42" STENCILINK	\$ 6.40	\$ 7.40	
STENCILINK-48	D or M	48" STENCILINK	\$ 7.40	\$ 8.40	
STENCILINK-72	D or M	72" STENCILINK	\$ 10.80	\$ 12.20	
INK & ROLLERS FOR MYLAR STENCILS					
INK-B4		4 OUNCE BOTTLE OF STENCIL INK	\$ 8.00		
INK PAD		INK PAD	\$ 16.80		
R-1.5		1 1/2" ROLLER	\$ 24.80		
R-3		3" ROLLER	\$ 25.20		
R-6		6" ROLLER	\$ 44.20		

PART# **6' or 7'** **TOOL DESCRIPTION** **6'** **7'**

ASPHALT LUTES

** ADD TB AFTER PART # FOR TRIANGLE BRACKET ***

LUTE-30	6 or 7	30" ASPHALT LUTE - 6' OR 7' HANDLE	\$ 68.20	\$ 72.20
LUTE-36	6 or 7	36" ASPHALT LUTE - 6' OR 7' HANDLE	\$ 73.00	\$ 77.00
LUTE-42	6 or 7	42" ASPHALT LUTE - 6' OR 7' HANDLE	\$ 77.80	\$ 81.80
LUTE-48	6 or 7	48" ASPHALT LUTE - 6' OR 7' HANDLE	\$ 82.40	\$ 86.40

ALUM-	6 or 7	6' or 7' X 1 1/4" YELLOW ALUMINUM HANDLE	\$ 28.50	\$ 32.50
ALUM-BRACE		LONG ARM BRACE KIT FOR LUTES & SQUEEGEES	\$ 21.30	
ALUM-TB		TRIANGLE BRACKET FOR LUTES & SQUEEGEES	\$ 21.30	

ASPHALT RAKE

HSR	6	14 TEETH X 17" WIDE 72" LONG	\$ 80.00	
-----	---	------------------------------	----------	--

SEALCOATING

SQUEEGEES

** ADD TB AFTER PART # FOR TRIANGLE BRACKET ***

ADJS-24	6 or 7	24" ADJUSTABLE SQUEEGEE 6' OR 7' HANDLE	\$ 70.80	\$ 74.80
ADJS-30	6 or 7	30" ADJUSTABLE SQUEEGEE 6' OR 7' HANDLE	\$ 71.60	\$ 75.60
ADJS-36	6 or 7	36" ADJUSTABLE SQUEEGEE 6' OR 7' HANDLE	\$ 77.80	\$ 81.80
ADJS-48	6 or 7	48" ADJUSTABLE SQUEEGEE 6' OR 7' HANDLE	\$ 91.40	\$ 95.40
ADJS-60	6 or 7	60" ADJUSTABLE SQUEEGEE 6' OR 7' HANDLE	\$ 105.20	\$ 109.20
ADJS-72	6 or 7	72" ADJUSTABLE SQUEEGEE 6' OR 7' HANDLE	\$ 118.20	\$ 122.20

CLPS-24	6 or 7	24" CLAMP STYLE SQUEEGEE 6' OR 7' HANDLE	\$ 73.80	\$ 77.80
CLPS-30	6 or 7	30" CLAMP STYLE SQUEEGEE 6' OR 7' HANDLE	\$ 79.80	\$ 83.80
CLPS-36	6 or 7	36" CLAMP STYLE SQUEEGEE 6' OR 7' HANDLE	\$ 85.00	\$ 89.00
CLPS-48	6 or 7	48" CLAMP STYLE SQUEEGEE 6' OR 7' HANDLE	\$ 101.80	\$ 105.80
CLPS-60	6 or 7	60" CLAMP STYLE SQUEEGEE 6' OR 7' HANDLE	\$ 114.80	\$ 118.80
CLPS-72	6 or 7	72" CLAMP STYLE SQUEEGEE 6' OR 7' HANDLE	\$ 128.20	\$ 132.20

WHS-24	NONE	24" SQUEEGEE NEEDS WOOD HANDLE (TAPER-72)	\$ 38.00	
WHS-30	NONE	30" SQUEEGEE NEEDS WOOD HANDLE (TAPER-72)	\$ 44.00	
WHS-36	NONE	36" SQUEEGEE NEEDS WOOD HANDLE (TAPER-72)	\$ 52.00	

CAR STOP

PRICE

SQUEEGEES

CSS-06PUSH		6" PUSH CAR STOP SQUEEGEE WITH HANDLE	\$ 42.00	
CSS-06PULL		6" PULL CAR STOP SQUEEGEE WITH HANDLE	\$ 42.00	
CSS-06B		6" CAR STOP REPLACEMENT BLADE	\$ 10.00	
CSS-10PUSH		10" PUSH CAR STOP SQUEEGEE WITH HANDLE	\$ 46.00	
CSS-10PULL		10" PULL CAR STOP SQUEEGEE WITH HANDLE	\$ 46.00	
CSS-10B		10" CAR STOP REPLACEMENT BLADE	\$ 11.50	

CRACK

SQUEEGEES

PRICE

VTAN	PUSH or PULL	V-SQUEEGEE TAN RUBBER REVERSIBLE	\$ 59.00	
VBLK	PUSH or PULL	V-SQUEEGEE BLACK RUBBER REVERSIBLE	\$ 67.60	
VRED	PUSH or PULL	V-SQUEEGEE RED RUBBER REVERSIBLE	\$ 69.20	
UBLK	PUSH or PULL	U-SQUEEGEE BLACK RUBBER REVERSIBLE	\$ 65.00	
URED	PUSH or PULL	U-SQUEEGEE RED RUBBER REVERSIBLE	\$ 71.00	

CRACK HOE

PRICE

TH-4		TRIANGLE SHAPED CRACK HOE 3" X 5" X 1/8" X 53" LONG	\$ 34.00	
------	--	---	----------	--



LUTE



LUTE-__TB



HSR

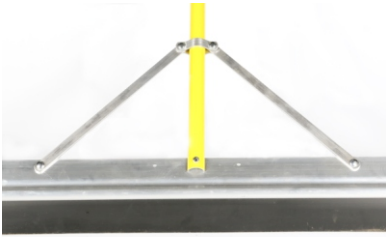

ADJS

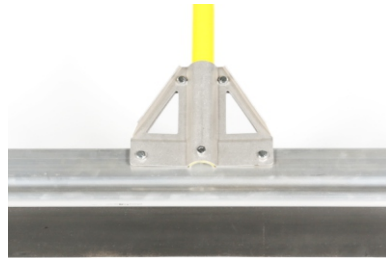

ADJS-__TB



CLPS

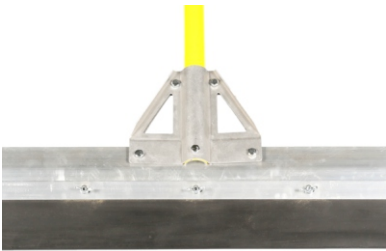

CLPS-__TB



WHS



CSS



VBLK

VTAN

VRED



URED

UBLK



TH-4



PP



PPW



BM



HST



PS-105



PS-145



DG-36



T10S



T8S



T8A



BC-18, 24, 36



BC-B



BC-HA6



WB-16

WB-16-B

PB-16

FWB-12



BR-B



BRM-HA6

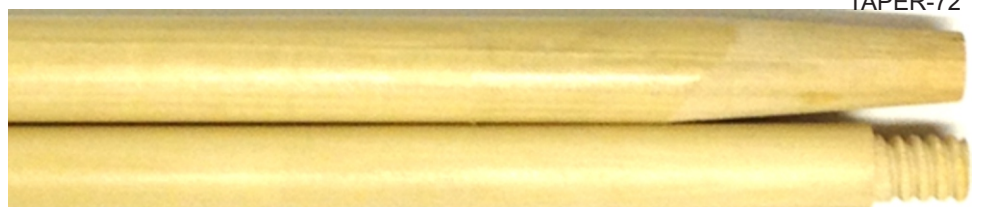

TAPER-72

THREAD-72

<u>PART #</u>		<u>TOOL DESCRIPTION</u>	<u>PRICE</u>
<u>LAYOUT TOOLS</u>			
TAPE-300		300' PREMARKED LAYOUT TAPE	\$ 270.00
PLP		PARKING LOT PROTRACTOR	\$ 66.00
G110		110' CHALK LINE	\$ 52.00
G150		150' CHALK LINE	\$ 80.00
BSCYELLOW		LAYOUT CRAYON	\$ 1.40
LCHOLDER		CRAYON HOLDER	\$ 13.00
RCWBULK		LAYOUT CHALK	\$ 0.60
<u>CAUTION TAPE</u>			
CT-1000		CAUTION TAPE 1000FT 1.5MIL	\$ 15.00
<u>REPLACEMENT BLADES</u>			
LUTE-30B		30" LUTE REPLACEMENT BLADE	\$ 28.40
LUTE-36B		36" LUTE REPLACEMENT BLADE	\$ 34.00
LUTE-42B		42" LUTE REPLACEMENT BLADE	\$ 39.80
LUTE-48B		48" LUTE REPLACEMENT BLADE	\$ 45.40
ADJS-24B		24" ADJUSTABLE SQUEEGEE REPLACEMENT BLADE	\$ 20.40
ADJS-30B		30" ADJUSTABLE SQUEEGEE REPLACEMENT BLADE	\$ 25.40
ADJS-36B		36" ADJUSTABLE SQUEEGEE REPLACEMENT BLADE	\$ 30.80
ADJS-48B		48" ADJUSTABLE SQUEEGEE REPLACEMENT BLADE	\$ 40.60
ADJS-60B		60" ADJUSTABLE SQUEEGEE REPLACEMENT BLADE	\$ 50.60
ADJS-72B		72" ADJUSTABLE SQUEEGEE REPLACEMENT BLADE	\$ 60.80
CLPS-24B		24" CLAMP STYLE SQUEEGEE REPLACEMENT BLADE	\$ 15.00
CLPS-30B		30" CLAMP STYLE SQUEEGEE REPLACEMENT BLADE	\$ 19.20
CLPS-36B		36" CLAMP STYLE SQUEEGEE REPLACEMENT BLADE	\$ 20.00
CLPS-48B		48" CLAMP STYLE SQUEEGEE REPLACEMENT BLADE	\$ 30.00
CLPS-60B		60" CLAMP STYLE SQUEEGEE REPLACEMENT BLADE	\$ 37.60
CLPS-72B		72" CLAMP STYLE SQUEEGEE REPLACEMENT BLADE	\$ 44.80
VTAN-B		12" TAN V-SQUEEGEE REPLACEMENT BLADE	\$ 8.00
VBLK-B		12" BLACK V-SQUEEGEE REPLACEMENT BLADE	\$ 9.40
VRED-B		12" RED V-SQUEEGEE REPLACEMENT BLADE	\$ 15.00
UBLK-B		18" BLACK U-SQUEEGEE REPLACEMENT BLADE	\$ 9.40
URED-B		18" RED U-SQUEEGEE REPLACEMENT BLADE	\$ 15.00
PS-10B		10" STAINLESS STEEL BLADE	\$ 28.20
PS-14B		14" SPRING STEEL BLADE	\$ 20.80



TAPE-300



PLP



G110



G150



LCHOLDER

BSCYELLOW



RCWBULK



CT-1000



LUTE-__B

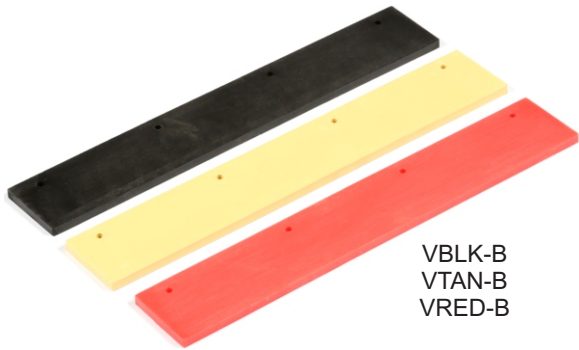

VBLK-B
VTAN-B
VRED-B



URED-B
UBLK-B



ADJS-__B



CLPS-__B

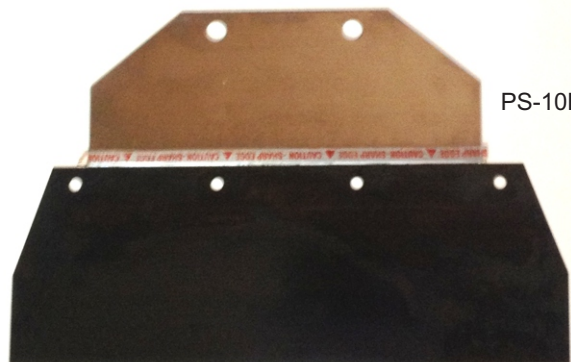

PS-10B

PS-14B

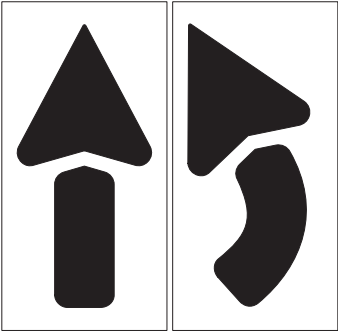
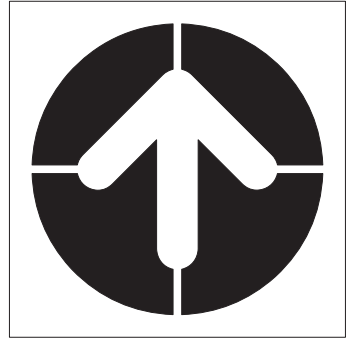
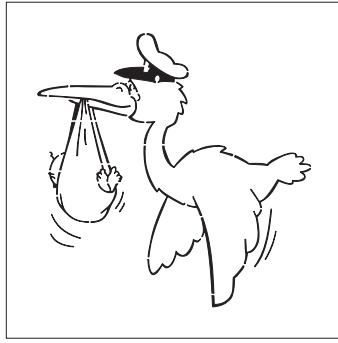

**THRU
DRIVE**

**YOU
THANK**



**FOR SAFETY
BUCKLE-UP**

PRUS

